

# POWER MOLLER® 24!

## Brushless DC Motor Driver 【CB-016[S7][BS7][P7][BP7]】User Manual

Thank you for purchasing a Itoh Denki CB-016 series motor driver. Please read this manual before operating the product, and keep this manual readily accessible for reference.

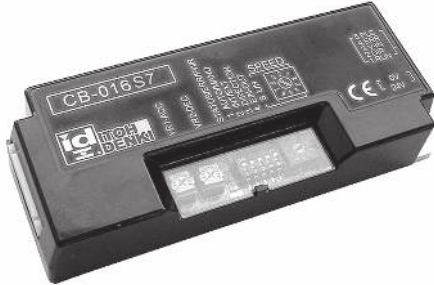

### Applicable MDR models

PM486FE • PM500FE  
PM486FS • PM500FP  
PM486FP  
PM570FE • PM605FE • PMT42FE

### Motor driver model

CB-016S7/LT-UL

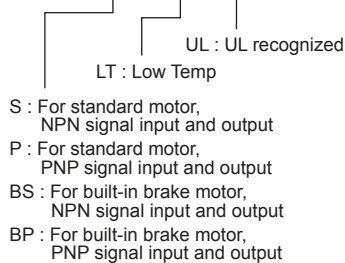

**ITOH DENKI** ITOH DENKI CO.,LTD.

No.491

## INDEX

1 Safety Instructions	(1)
2 Power	(2)
3 Before Operating the Product	
3-1 Mounting	(2)
3-2 Wiring	(2) ~ (3)
3-3 Direction Setting	(3)
4 Functions	(3) ~ (4)
5 Operation Instructions	
5-1 Speed Variation	(4)
5-1-1 Internal Speed Variation	(4) ~ (6)
5-1-2 External Speed Variation	(4) ~ (6)
5-2 Direction Setting	(7)
5-3 Acceleration and Deceleration	(7)
6 Error Signal Output	(7)
7 Motor Pulse Signal Output	(8)
8 Error status, Reset, History	(8) ~ (9)
8-1 Error History	(9)
8-2 Indication of Error Occurrence Frequency	(10) ~ (11)
9 Troubleshooting	(12)
10 Dimensions	(13)
11 Product specifications	(13)
12 Applicable standards ( -UL)	(13)

## Standard Accessories

- Power connector (CN 1) — 1pc
- Control connector (CN 2) — 1pc
- Mounting screws and nuts
  - Screw M4 x 15 — 2pcs
  - Nut M4 — 2pcs

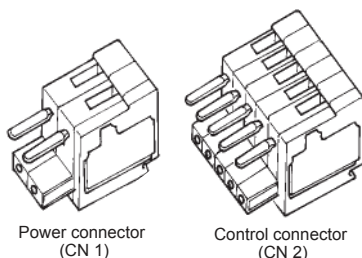

## Warning & Caution

Shown below are the caution items for using the product safely and avoiding danger and damage to the user. Caution items can be classified into danger, warning and caution as described below.

<b>Warning</b>	Incorrect handling may lead to death or serious injury, indicating potential danger.
<b>Caution</b>	Possible danger of light or medium injury, or only a material damage.

## 1 Safety Instructions

### Caution

- Maximum Surrounding Air Temperature 40°C.
- Switch off the power, when removing from conveyor, wiring or maintenance is done, otherwise you have a risk of electrical shock or injury.
- Respect the electrical regulations of the site or the equipment, where the product is installed. (Labor safety and sanitary regulations, electrical equipment technical standard, etc)
- Operate the motor driver within its intended design and specifications to avoid electrical shock, injury, fire, or damage to the equipment.
- Do not disassemble, repair nor modify the product (for which we do not warrant) It might cause electrical shock, injury or fire.
- Separately set the circuitry to monitor the important input and/or output signal status, which might cause accident, because the signal may stay ON or OFF in case of the CB-016 driver card failure.
- Be sure to shut off the power before inserting or removing any connector. Do not wire connector left in the CB-016 driver card.
- Do not drop, give external impact nor pressure to the CB-016 driver card. If that happens, do not reuse it.
- Make sure all the connectors are properly engaged with wiring cables.
- Make sure the conveyor frame and control box where the CB-016 driver card is mounted are grounded.
- Do not switch on or off the relay or contactor in close proximity to power or signal lines, or the CB-016 driver card as the generated noise could cause malfunction.
- Be sure to inject power or input signal for 15 milli-seconds or over to ensure the proper reaction.
- Use the MDR with built-in brake option (BR) along with CB-016 driver card [BS7] [BP7] if holding effect is needed.
- Do not pull by force during operation. It causes the CB-016 driver card to malfunction.
- Do not force the MDR to turn. It may cause of damage to the driver card or shorten its life cycle.

<Described below are the precautions for using this product at freezing temperature along with MDR having LT option:>

- Connector may harden with low temperature. Do not insert or pull it by force.
- Mount this product to the place where MDR can be properly connected without cable loose, extreme bend or pull, or move.
- MDR speed may not reach immediately to the set speed if it is left long hours in 0°C or below. In addition, the starting current may get larger to activate thermister, or under voltage error may be resulted. Therefore, warm up operation is recommended before formal use.
- Be careful for condensation or freeze in case the product is used in varying temperature particularly between below and above 0°C. If condensation is generated, do not use the product until it is completely removed. Use of the product having condensation may result in malfunction or electrical accident.

## 2 Power

24VDC battery or switching power (24VDC 5A) or smoothed and rectified power ( $\leq 10\%$  ripple)

- \* Use stable power supply with 5A or over. The Power supply should not be affected by peak current 20A for 1msec.

In case of using UL recognized product.

- \* Battery shall not be used for power supply.

Accommodated DC power

DC power source supplied to the product need to be accommodated to the following conditions.

### 1) Recommended specification of power supply

- Stabilized power supply that isolates between output and input. (24 V DC / 5A)
- Conforming to safety standards as below.

US: UL60950-1, IEC60950-1

Canada: CSA C22.2 No.60950-1

### 2) Power supply specification for the product.

	Condition
Input voltage range	100 to 230 V AC ( $\pm 15\%$ )
Input frequency range	50 to 60 Hz ( $\pm 5\%$ )
Output voltage range	24 V DC ( $\pm 5\%$ )
Rated output current	5A or over
Operating ambient temperature	0 to 40 deg. C
Humidity	90% RH or less (No condensation)
Safety standard	Conforming to UL60950-1 or IEC60950-1 in the US. CSA C22.2 No.60950-1 in Canada.

\* The installation of specific over current protection device in power source might be requested by specification DC power source that would requests safety standard (UL60950-1, etc.). In this case, install specified over current protection device .

\* Overcurrent protective device must be provided in 24VDC power input circuit, when using a power supply other than Limited Power Source (LPS).

## 3 Before Operating the Product

### 3-1 Mounting

The product is defined as "Open Type" complying with UL508C standard. Therefore, in order to conform to UL on the installation, the device must to be installed in the proper enclosure.

#### ① Drill mounting holes in the conveyor frame to fit the fixing holes in the product (see 10 Dimensions )

- \* The product's back place should be affixed to metallic plate face to ensure the heat dissipation. Care must be paid to prevent the metallic dust entry to the product.
- \* Make sure the conveyor is adequately grounded.

#### ② Fix the product tightly to the conveyor frame with the supplied mounting screws and nuts with the recommended fastening torque between 1.5Nm $\pm$ 20%

### 3-2 Wiring

The product discharges an abnormal status data, when abnormal circumstances such as overload or high temperature rising condition, but does not block out the power . Therefore, if the power needs to be blocked out, add a external device that detects abnormal circumstances and block out the motor power or add a circuit breaker on motor power line that is controlled by upper layer device (PLC etc.).

Motor overload and over-temperature sensing is not provided by the driver card.

- Wiring should be made while the product is not powered.
- Switch for Run/stop or CW/CCW is an option and is not supplied.
- Relay contact or PLC output can be used instead of the above switch.
- Wiring to the supplied connectors should be made before inserting into the driver card.

[Wiring diagram]

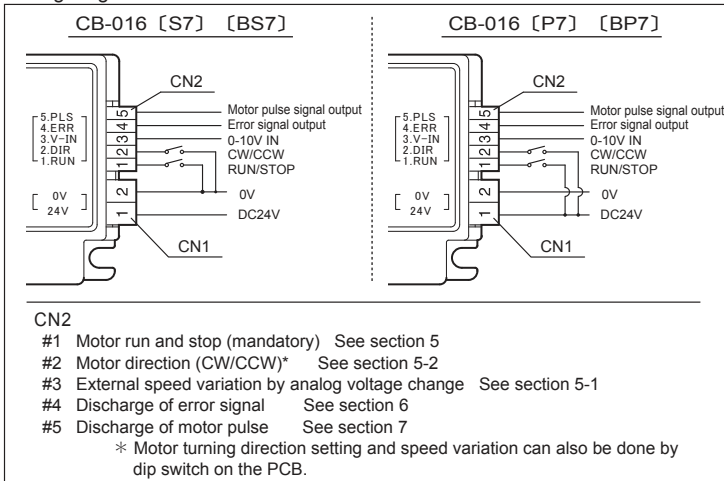

(2)

#### ① Wire 24VDC and 0V to the Power Connector CN 1(2P)

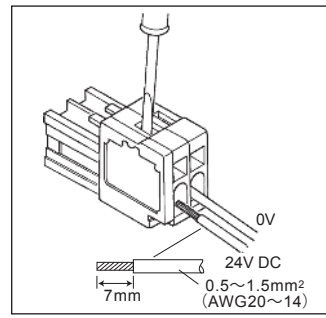

- \* Connector current capacity is 10A. Avoid wiring causing excessive current.
- \* Make sure the +/- wiring is correct.
- \* Wiring should be made before inserting into the driver card.

#### ② Wire to the Control Connector CN 2 (5P) per the diagram in section 3

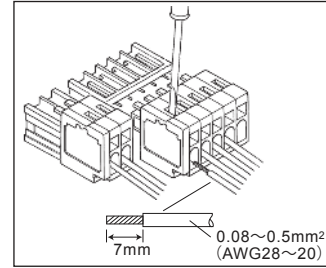

- \* 0V to CN2-1 and CN2-2 should be common to the power voltage. (connector current capacity is 4A)
- \* Analog voltage input to CN2-3 should not exceed 10V. 0V should be common to the power voltage.
- \* Error signal from CN2-4 is PNP open collector.
- \* Motor pulse signal from CN2-5 is NPN open collector.

#### ③ Insert the pre-wired Power Connector CN 1, Control Connector CN 2 and motor connector respectively to the counter connectors in the driver card (motor connector to CN 3) while the power is shut off.

## 3-3 Direction setting

Dip switch 1-3 is to select the motor turning direction viewed from the MDR's power cable side. The setting differs according to the MDR model. Check the model from the circular label put on the MDR end housing.

Model nomenclature

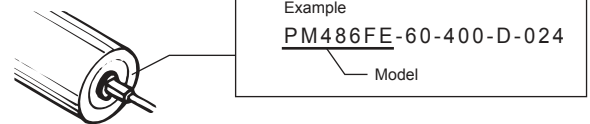

### Dip Switch 1-3 setting

	SW 1-3	
	ON	OFF
FE type	CW	CCW
FS/FP type	CCW	CW

## 4 Functions

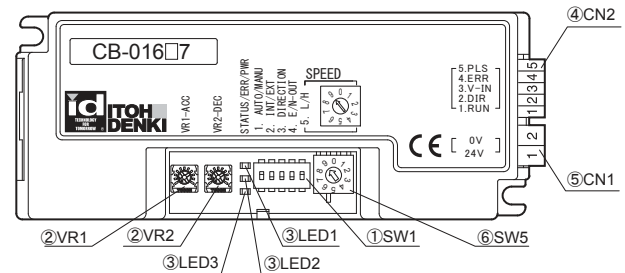

### ① Dip Switch (SW1)

No	Function	ON	OFF	Default	Remarks
SW1-1	Thermister/Under voltage reset	Manual	Automatic	ON	See section 8
SW1-2	Speed variation	External	Internal	OFF	See section 5-1
SW1-3	Turning direction	See 5-2		OFF	See section 5-2
SW1-4	Error signal	Discharges in normal status	Discharges when error arises	ON	See section 6
SW1-5	Speed range	High range	Low range	ON	See section 5-1

### ② Potentiometer (VR)

	Min	Max	Default	Remarks	
	(To the CCW end.)				
1	Acceleration from RUN signal	0 sec	2.5 sec	Min	See section 5-3
2	Deceleration from STOP signal	0 sec	2.5 sec	Min	

(3)

### ③ LEDs

	Color	Status	Remarks
1	Green	Powered and functions normally	See section 8
2	Red	Indicates type of error	
3	Orange	Indicates number of error occurrence form thermister reaction, motor stall or under voltage	See section 9

### ④ Control Connector (CN 2)

	Function	Remarks
5	Motor pulse signal output	See section 7
4	Error signal output	See section 6
3	External speed variation	See section 5-1
2	Motor turning direction	See section 5-2
1	Motor Run/Stop	See section 5

### ⑤ Power Connector (CN 1)

2	0V
1	24VDC

### ⑥ Rotary Switch (SW 5)

10 index speed setting

## 5 Operation Instructions

Ensure the following before operating the product

- MDR is adequately installed in compliance with the manual.
- MDR shafts are adequately secured with the supplied brackets or accessories.
- Each connector on the driver card is adequately wired and inserted.
- Operating and environmental conditions are respected.
- Power supply has sufficient capacity (stable 24VDC, 5A or over) so as not to be affected by varying load.  
The protector for the power supply should not react with peak current 20A 1 milli-second or less.

- Supply 24VDC to the driver card, and the LED 1 (green) illuminates.

- Close the contact of CN2-1, and the MDR starts running.

- \* 0V should be common to the power voltage.
- \* 3mA current is drawn to CN2-1.
- \* Wait 1 second after the driver card is powered before running MDR.

- Open the contact of CN2-1, and the MDR stops.

- \* MDR run/stop should be manipulated only by CN2-1 and 0V, not by the 24VDC power to the driver card.

- To vary the motor speed, follow the section 5-1.
- To reverse the motor, follow the section 5-2.
- To accelerate or decelerate the motor, follow the section 5-3.

### 5-1 Speed Variation

Speed of the MDR can be varied either internally by integral dip switch or externally by analog voltage input.

- Range of speed variation differs according to the MDR model. Check the nominal speed of the model from the circular label put on its end housing.

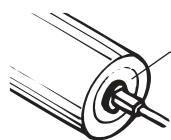

Example  
**PM486FE-60-400-D-024**  
 Model      Nominal Speed

#### [5-1-1 Internal Speed variation]

- Set the SW1-2 OFF to effect the internal speed variation.
- With the combination of SW1-5 and Rotary Switch SW5, speed can be varied in 20 steps.

#### [5-1-2 External Speed Variation]

- Set the SW1-2 ON to effect the external speed variation.
- Inject and vary the analog voltage between 0 and 10V to CN2-3 to vary the motor speed in 20 steps.
  - \* Max 2mA current is consumed at CN2-3.
  - \* The analog voltage input should not exceed 10V. Its 0V should be common to the Power voltage.

### PM486FE

Speed deviation +/-3%

Internal speed variation	SW 5	*1 MDR Rated Speed (m/min)			Analog voltage input
		*2 Type 210	Type 60	Type 17	
ON	9	184.9	*3 52.0	*3 14.6	9.6~9.9
	8	184.9	*3 52.0	*3 14.6	9.1~9.4
	7	184.9	*3 52.0	*3 14.6	8.6~8.9
	6	177.8	50.0	14.1	8.1~8.4
	5	168.9	47.5	13.4	7.6~7.9
	4	160.0	45.0	12.7	7.1~7.4
	3	142.2	40.0	11.2	6.6~6.9
	2	133.3	37.5	10.5	6.1~6.4
	1	124.4	35.0	9.8	5.6~5.9
	0	115.6	32.5	9.1	5.1~5.4
OFF	9	106.7	30.0	8.4	4.6~4.9
	8	97.8	27.5	7.7	4.1~4.4
	7	88.9	25.0	7.0	3.6~3.9
	6	80.0	22.5	6.3	3.1~3.4
	5	71.1	20.0	5.6	2.6~2.9
	4	62.2	17.5	4.9	2.1~2.4
	3	53.3	15.0	4.2	1.6~1.9
	2	44.4	12.5	3.5	1.1~1.4
	1	35.6	10.0	2.8	0.6~0.9
	0	26.7	7.5	2.1	0.1~0.4

### PM486FP

Speed deviation +/-3%

Internal speed variation	SW 5	*1 MDR Rated Speed (m/min)			Analog voltage input
		*2 Type 255	Type 55	Type 15	
ON	9	243.7	*3 53.5	*3 14.2	9.6~9.9
	8	243.7	*3 53.5	*3 14.2	9.1~9.4
	7	243.7	*3 53.5	*3 14.2	8.6~8.9
	6	243.7	53.5	14.2	8.1~8.4
	5	235.1	51.6	13.7	7.6~7.9
	4	222.8	48.9	13.0	7.1~7.4
	3	197.7	43.4	11.5	6.6~6.9
	2	185.4	40.7	10.8	6.1~6.4
	1	173.1	38.0	10.1	5.6~5.9
	0	160.8	35.3	9.4	5.1~5.4
OFF	9	148.5	32.6	8.6	4.6~4.9
	8	136.2	29.9	7.9	4.1~4.4
	7	123.5	27.1	7.2	3.6~3.9
	6	111.2	24.4	6.5	3.1~3.4
	5	98.9	21.7	5.7	2.6~2.9
	4	86.6	19.0	5.0	2.1~2.4
	3	74.3	16.3	4.3	1.6~1.9
	2	62.0	13.6	3.6	1.1~1.4
	1	49.7	10.9	2.9	0.6~0.9
	0	36.9	8.1	2.1	0.1~0.4

### PM500FE

Speed deviation +/-3%

Internal speed variation	SW 5	*1 MDR Rated Speed (m/min)			Analog voltage input
		*2 Type 210	Type 60	Type 17	
ON	9	190.2	*3 53.5	*3 15.0	9.6~9.9
	8	190.2	*3 53.5	*3 15.0	9.1~9.4
	7	190.2	*3 53.5	*3 15.0	8.6~8.9
	6	182.9	51.4	14.5	8.1~8.4
	5	173.8	48.9	13.7	7.6~7.9
	4	164.6	46.3	13.0	7.1~7.4
	3	146.3	41.2	11.6	6.6~6.9
	2	137.2	38.6	10.9	6.1~6.4
	1	128.0	36.0	10.1	5.6~5.9
	0	118.9	33.4	9.4	5.1~5.4
OFF	9	109.7	30.9	8.7	4.6~4.9
	8	100.6	28.3	8.0	4.1~4.4
	7	91.5	25.7	7.2	3.6~3.9
	6	82.3	23.1	6.5	3.1~3.4
	5	73.2	20.6	5.8	2.6~2.9
	4	64.0	18.0	5.1	2.1~2.4
	3	54.9	15.4	4.3	1.6~1.9
	2	45.7	12.9	3.6	1.1~1.4
	1	36.6	10.3	2.9	0.6~0.9
	0	27.4	7.7	2.2	0.1~0.4

\* 1 Consult local ITOH DENKI representative in case you use MDR with rated speed not in the above table.

\* 2 It is not available for Low temperature applications(LT)

\* 3 It is not available at temperatures of -30 to 0 degrees or less for LT.

**PM500FP**

Speed deviation +/-3%

Internal speed variation		*1 MDR Rated Speed (m/min)			Analog voltage input
SW1-5	SW 5	*2 Type 255	Type 55	Type 15	
ON	9	250.7	*3 55.0	*3 14.6	9.6~9.9
	8	250.7	*3 55.0	*3 14.6	9.1~9.4
	7	250.7	*3 55.0	*3 14.6	8.6~8.9
	6	250.7	55.0	14.6	8.1~8.4
	5	241.8	53.1	14.1	7.6~7.9
	4	229.2	50.3	13.3	7.1~7.4
	3	203.4	44.7	11.8	6.6~6.9
	2	190.8	41.9	11.1	6.1~6.4
	1	178.1	39.1	10.4	5.6~5.9
	0	165.4	36.3	9.6	5.1~5.4
OFF	9	152.8	33.5	8.9	4.6~4.9
	8	140.1	30.8	8.1	4.1~4.4
	7	127.0	27.9	7.4	3.6~3.9
	6	114.4	25.1	6.6	3.1~3.4
	5	101.7	22.3	5.9	2.6~2.9
	4	89.0	19.5	5.2	2.1~2.4
	3	76.4	16.8	4.4	1.6~1.9
	2	63.7	14.0	3.7	1.1~1.4
	1	51.1	11.2	3.0	0.6~0.9
	0	38.0	8.3	2.2	0.1~0.4

**PM570FE**

Speed deviation +/-3%

Internal speed variation		*1 MDR Rated Speed (m/min)			Analog voltage input
SW1-5	SW 5	*2 Type 210	Type 60	Type 17	
ON	9	216.8	*3 61.0	*3 17.2	9.6~9.9
	8	216.8	*3 61.0	*3 17.2	9.1~9.4
	7	216.8	*3 61.0	*3 17.2	8.6~8.9
	6	208.5	58.6	16.5	8.1~8.4
	5	198.1	55.7	15.7	7.6~7.9
	4	187.7	52.8	14.8	7.1~7.4
	3	166.8	46.9	13.2	6.6~6.9
	2	156.4	44.0	12.4	6.1~6.4
	1	146.0	41.0	11.5	5.6~5.9
	0	135.5	38.1	10.7	5.1~5.4
OFF	9	125.1	35.2	9.9	4.6~4.9
	8	114.7	32.3	9.1	4.1~4.4
	7	104.3	29.3	8.2	3.6~3.9
	6	93.8	26.4	7.4	3.1~3.4
	5	83.4	23.5	6.6	2.6~2.9
	4	73.0	20.5	5.8	2.1~2.4
	3	62.6	17.6	4.9	1.6~1.9
	2	52.1	14.7	4.1	1.1~1.4
	1	41.7	11.7	3.3	0.6~0.9
	0	31.3	8.8	2.5	0.1~0.4

**PM605FE**

Speed deviation +/-3%

Internal speed variation		*1 MDR Rated Speed (m/min)			Analog voltage input
SW1-5	SW 5	*2 Type 210	Type 60	Type 17	
ON	9	230.2	*3 64.7	*3 18.2	9.6~9.9
	8	230.2	*3 64.7	*3 18.2	9.1~9.4
	7	230.2	*3 64.7	*3 18.2	8.6~8.9
	6	221.3	62.2	17.5	8.1~8.4
	5	210.2	59.1	16.6	7.6~7.9
	4	199.2	56.0	15.8	7.1~7.4
	3	177.0	49.8	14.0	6.6~6.9
	2	166.0	46.7	13.1	6.1~6.4
	1	154.9	43.6	12.3	5.6~5.9
	0	143.9	40.5	11.4	5.1~5.4
OFF	9	132.8	37.3	10.5	4.6~4.9
	8	121.7	34.2	9.6	4.1~4.4
	7	110.7	31.1	8.8	3.6~3.9
	6	99.6	28.0	7.9	3.1~3.4
	5	88.5	24.9	7.0	2.6~2.9
	4	77.5	21.8	6.1	2.1~2.4
	3	66.4	18.7	5.3	1.6~1.9
	2	55.3	15.6	4.4	1.1~1.4
	1	44.3	12.4	3.5	0.6~0.9
	0	33.2	9.3	2.6	0.1~0.4

- \*1 Consult local ITOH DENKI representative in case you use MDR with rated speed not in the above table.
- \*2 It is not available for Low temperature applications(LT)
- \*3 It is not available at temperatures of -30 to 0 degrees or less for LT.

**5-2 Direction Setting**

Reverse direction by external DIR signal can be permitted even while motor is running. MDR turning direction can be set or changed either internally by integral dip switch or externally by optional switch.

**Setting for Turning Direction**

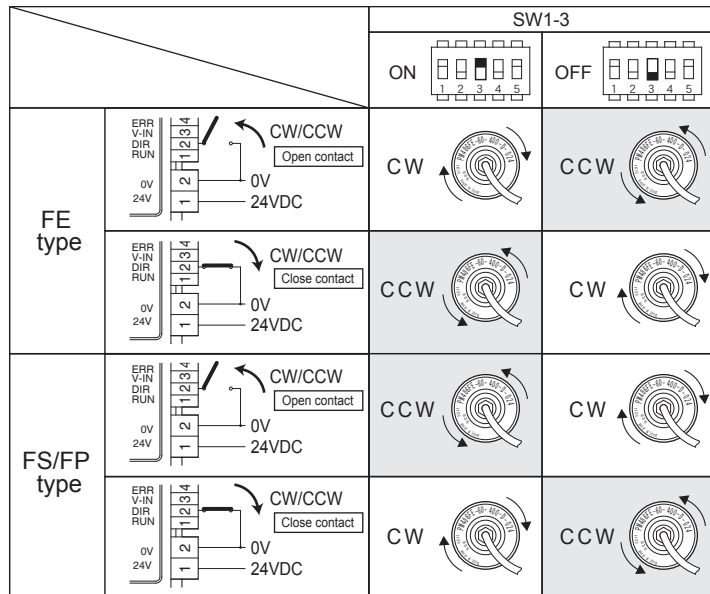

- \* Turning direction viewed from the MDR's power cable side.
- \* 0V should be common to power voltage.
- \* 3mA current is drawn at CN2-2

**Reverse motor direction by external DIR signal.**

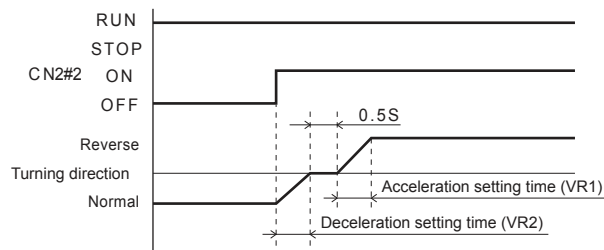

Reverse direction by DIP switch is prohibited while motor is running. Motor must be stopped first, and then reverse a direction by DIP switch.

**5-3 Acceleration and Deceleration**

- Integral potentiometer VR 1 allows the acceleration adjustment from 0 to 2.5 seconds.
- Integral potentiometer VR 2 allows the deceleration adjustment from 0 to 2.5 seconds.

The adjustable range of time is on the control basis, thus may differs on actual transfer speed.

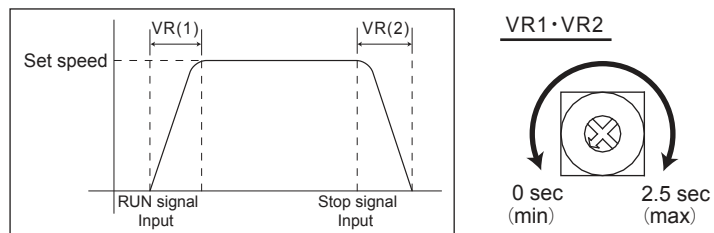

**6 Error Signal Output**

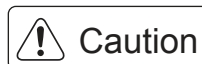

- To monitor the error signal, a protective resistor should be mounted to suppress 24VDC to 25mA or less.
- The driver card has 100Ω protective resistor.

Error signal is discharged from CN2-4

Disregard the error signal discharged when power is injected to the driver card (for 0.5 sec) and when power to the driver card is shut off (for 2 seconds)

- SW1-4 allows the selection of the error signal discharge timing: discharge on normal status or discharge when error arises. Error signal is PNP open collector.
- \* See section 8 for error status, reset and history.

SW1-4 ON	SW1-4 OFF
Error signal discharges in normal status	Error signal discharges when error arises
Open on error	Open on normal

## 7 Motor Pulse Signal Output



- Protective resistor should be mounted to suppress the output to be 25mA or less, otherwise the driver card's integral transistor may be damaged.
- 100Ω resistor is built-in the driver card's output section for motor pulse signal.

- MDR's motor pulse signal is discharged from CN2-5.
- 2 pulses/motor rotation, NPN open collector output.

Speed deviation +/-3%

Internal speed variation		Frequency (Hz)	Motor speed (rpm)	Analog voltage input
SW1-5	SW5			
ON	9	155	4638	9.6~9.9
	8	152	4556	9.1~9.4
	7	145	4349	8.6~8.9
	6	138	4141	8.1~8.4
	5	131	3934	7.6~7.9
	4	124	3727	7.1~7.4
	3	110	3313	6.6~6.9
	2	104	3106	6.1~6.4
	1	97	2899	5.6~5.9
	0	90	2692	5.1~5.4
OFF	9	83	2485	4.6~4.9
	8	76	2278	4.1~4.4
	7	69	2071	3.6~3.9
	6	62	1864	3.1~3.4
	5	55	1657	2.6~2.9
	4	48	1450	2.1~2.4
	3	41	1242	1.6~1.9
	2	35	1035	1.1~1.4
	1	28	828	0.6~0.9
	0	21	621	0.1~0.4

## 8 Error Status, Reset and History

- When error arises, the error can be identified either by LED 1 (green) and LED 2 (red), or by the error signal discharged from CN2-4.

- To reset the error status, first remove the cause of error, and then switch the direction signal at CN2-2.
- To restart the MDR, first remove the cause of error, and then re-inject run signal at CN2-1.
- Please have 100ms or more intervals between each switch for ON→OFF→ON / OFF→ON→OFF / RUN→STOP→RUN to release error signal or restart MDR.

### LED indication

: Illuminates   
 : blinks at 1Hz   
 : blinks at 6Hz   
 : off

LED 1 (green)	CN2-4 (Error signal)		MDR	Symptom/Causes	Reset the error signal	Restart the MDR
	SW1-4 OFF	SW1-4 ON				
	Open	Discharge	n.a.	Normal operation	n.a.	
	Open	Open	Stop	No power	Supply 24VDC power	see 5 Operation Instructions
	Discharge	Open	Stop	PCB damaged	Shut off the power then replace the driver card	see 5 Operation Instructions
	Discharge	Open	Stop	Thermister reacted (Thermister error)	Automatic recovery setting	
					MDR restarts immediately 1 minute after thermister recovery from cooling off	
					MDR restarts by injecting RUN signal followed by STOP signal to CN2-1 to reset the error signal then inject RUN signal to CN2-1 to restart, 1 minute after thermister recovery	
					After thermister recovery, inject signal ON-OFF-ON or OFF-ON-OFF order to CN2-2	Inject signal RUN-STOP-RUN order to CN2-1
					Restarts automatically in a minute	
					Manual recovery setting	
MDR restarts by injecting RUN signal followed by STOP signal to CN2-1 to reset the error signal then inject RUN signal to CN2-1 to restart, 1 minute after thermister recovery						
After thermister recovery, inject signal ON-OFF-ON or OFF-ON-OFF order to CN2-2	Inject signal RUN-STOP-RUN order to CN2-1					

	Discharge	Open	Stop	Connector unplugged	Shut off the power and replug in the connector properly	see 5 Operation Instructions
	Discharge	Open	Stop	Motor cable disconnection	Shut off the power then replace the MDR	see 5 Operation Instructions
	Discharge	Open	Stop	Motor stall for 4 seconds (Stall error)	Inject signal RUN-STOP-RUN order to CN2-1 to reset the error and to restart	Inject signal RUN-STOP-RUN order to CN2-1 to restart
					Inject signal ON-OFF-ON or OFF-ON-OFF order to CN2-2	
	Open	Discharge	Run	Overload operation	Remove the causes of overload.	
	Discharge	Open	Stop	Supply voltage less than 18VDC (under voltage error)	Automatic recovery setting	
					Secure the stable supply voltage 18V or over	Restarts immediately or over
					Manual recovery setting	
					First secure the stable supply voltage 18V or over, then inject signal ON-OFF-ON or OFF-ON-OFF order to CN2-2	Inject signal RUN-STOP-RUN order to CN2-1 to restart

\* Error can also be reset by shutting off the power 2 seconds or over.

### 8-1 Error History

If thermister, motor stall or under voltage error arises while the MDR is running, the error status and frequency of error occurrence are identified by LED 2 and LED 3.

- LED of error history will not illuminate during normal operational condition, but when motor stops with next error.
- Please see section 8-2 for other type of error.

### LED indication

: Illuminates   
 : blinks at 1Hz   
 : blinks at 6Hz   
 : off

Motor stall error / under voltage error / thermister error

	stall error
	under voltage error
	thermister error





Shows the error history since the card is powered. See the below chart.

















































































	Error occurred at first time
	Error occurred at second time (same error as the first one)
	Error occurred at second time (different error from the first one)
	Error occurred at third time (same error as the first or second one)
	Error occurred at third time (same error in series)









































































## 8-2 Indication of Error Occurrence Frequency

Shows the occurrence frequency of thermister error, motor stall error or under voltage error.

### LED indication

 : Illuminates    
  : blinks at 1Hz    
  : blinks at 6Hz    
  : off

LED2(red)	LED3(orange)	Occurrence	Status
		0	normal
		first time	stall error
		second time	stall error
		≧ 3 times	stall error
		first time	stall error
		second time	stall error
		≧ 3 times	thermister error
		first time	stall error
		second time	thermister error
		≧ 3 times	stall error
		first time	stall error
		second time	thermister error
		≧ 3 times	thermister error
		first time	thermister error
		second time	stall error
		≧ 3 times	stall error
		first time	thermister error
		second time	stall error
		≧ 3 times	thermister error
		first time	thermister error
		second time	thermister error
		≧ 3 times	stall error
		first time	thermister error
		second time	thermister error
		≧ 3 times	thermister error
		first time	stall error
		second time	stall error
		≧ 3 times	under voltage error
		first time	stall error
		second time	under voltage error
		≧ 3 times	under voltage error
		first time	under voltage error
		second time	stall error
		≧ 3 times	stall error
		first time	under voltage error
		second time	stall error
		≧ 3 times	under voltage error
		first time	under voltage error
		second time	under voltage error
		≧ 3 times	stall error

LED2(red)	LED3(orange)	Occurrence	Status
		first time	under voltage error
		second time	under voltage error
		≧ 3 times	under voltage error
		first time	thermister error
		second time	thermister error
		≧ 3 times	under voltage error
		first time	thermister error
		second time	under voltage error
		≧ 3 times	thermister error
		first time	thermister error
		second time	under voltage error
		≧ 3 times	under voltage error
		first time	under voltage error
		second time	thermister error
		≧ 3 times	thermister error
		first time	under voltage error
		second time	thermister error
		≧ 3 times	thermister error
		first time	under voltage error
		second time	under voltage error
		≧ 3 times	thermister error
		first time	stall error
		second time	thermister error
		≧ 3 times	under voltage error
		first time	stall error
		second time	under voltage error
		≧ 3 times	thermister error
		first time	thermister error
		second time	stall error
		≧ 3 times	under voltage error
		first time	thermister error
		second time	stall error
		≧ 3 times	thermister error
		first time	under voltage error
		second time	thermister error
		≧ 3 times	stall error

## 9 Troubleshooting

\* Follow the procedures below without removing plastic cover or modifying the driver card, in case any problem happens.

Symptom 1: MDR does not run	
Power	<ul style="list-style-type: none"> <li>Check if only LED 1 (green) illuminates.</li> <li>Check if 24VDC stable voltage is adequately supplied from the power supply.</li> <li>Check if the wiring to CN1 connector is made correctly.</li> <li>Check if 24VDC cable is adequately wired to the CN 1 connector.</li> </ul>
RUN signal	<ul style="list-style-type: none"> <li>Check if 0V is injected to CN2-1.</li> <li>Check if the 0V injected to CN2-1 is common to 0V injected to CN1-2.</li> <li>Check if the wiring is adequately made to CN2-1 connector.</li> <li>Check if the SW2 is set to NPN.</li> </ul>
Error	<ul style="list-style-type: none"> <li>Check if LED 2 is illuminating or blinking.                             <ul style="list-style-type: none"> <li>» If this is the case, see section 8 and remove the cause of error.</li> </ul> </li> </ul>
MDR	<ul style="list-style-type: none"> <li>Check if the MDR is adequately installed and its shafts are adequately fixed with the supplied mounting brackets or accessories.</li> <li>Check if the MDR end housing is NOT contacting conveyor frame.</li> <li>Check if the MDR's connector is properly inserted to the driver card.</li> <li>Check if the o-ring or belt tension is not too strong.</li> <li>Check if the number of slaved idler rollers is adequate.</li> </ul>

Symptom 2 : Speed variation is not achieved, or speed is slower than expected	
MDR	<ul style="list-style-type: none"> <li>Check if the nominal speed of the MDR to see if the right model is used to achieve the speed variation or to reach expected speed.</li> </ul>
SW1-2 setting	<ul style="list-style-type: none"> <li>Check if the SW1-2 is set properly: ON for external speed variation and OFF for internal speed variation.</li> </ul>
Power	<ul style="list-style-type: none"> <li>In case of external speed variation, check if the 0V is common to the 0V input to CN1-2.</li> <li>Check if the stable 24VDC is supplied.</li> </ul>
CN2-3	<ul style="list-style-type: none"> <li>Check if the wiring is adequately made to CN2-3 connector.</li> <li>Check if the analog voltage input is made between 0 and 10V.</li> </ul>

Symptom 3 Reversing is not achieved	
CW/CCW	<ul style="list-style-type: none"> <li>Check if 0V is injected to CN2-2, and it is common to the 0V input to CN1-2.</li> <li>Check if the wiring is adequately made to CN2-1.</li> </ul>

Symptom 4 Error Signal Not Discharged	
SW1-4	<ul style="list-style-type: none"> <li>Check if the setting is made properly for discharge on normal or discharge when error arises.</li> </ul>
Voltage	<ul style="list-style-type: none"> <li>Check if the external voltage is 24VDC or less and its 0V is common to the 0V input to CN1-2.</li> <li>Check if the resistor larger than 1kΩ is mounted.</li> </ul>
CN2-4	<ul style="list-style-type: none"> <li>Check if the wiring is adequately done to CN2-4.</li> </ul>

Symptom 5 Error Signal is often Discharged	
LED 2 (red)	<ul style="list-style-type: none"> <li>Check if the LED 2 is blinking.                             <ul style="list-style-type: none"> <li>» If this is the case, see section 8 in page 7 and remove the cause of error.</li> </ul> </li> <li>Check if the wire diameter of the power supply is appropriate (0.5 to 1.5mm<sup>2</sup>). Also, check if there is no failure in wiring or no looseness at connectors.                             <ul style="list-style-type: none"> <li>» Check the wire diameter and wirings.</li> </ul> </li> <li>Check if CB-016 is too far from the power supply. (Check if the voltage is dropped.)</li> </ul>
Environment	<ul style="list-style-type: none"> <li>Check if the product is used in the ambient temperature range between 0 and 40°C. *1</li> <li>Check if the driver card back plate is affixed to the metallic plate face for better heat dissipation.</li> <li>Check if the MDR is stalled in the conveyor line.</li> </ul>
MDR	<ul style="list-style-type: none"> <li>Check if the MDR end housing is contacting the conveyor frame.</li> <li>Check if the MDR's connector is properly inserted to the driver card.</li> <li>Check if the MDR's connector is disconnected, or about to disconnect.</li> </ul>

\*1 CB-016 driver card having LT option is used in the ambient temperature range between -30 and 10 °C. (no condensation)

## 10 Dimensions

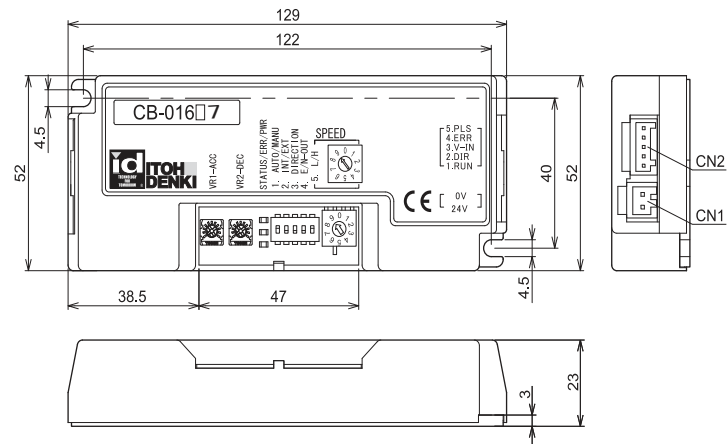

## 11 Specifications

Power voltage	24VDC ±10% (±5%) *5	Type of brake	Dynamic brake *1	
Rated voltage	24VDC		Connector (wiring side)	Power
Static current	0.03A	Control		P/N 733-105 (4A max) (Wire diameter : AWG28~20)
Peak current	20A , 1msec or less	MDR connector		JST P/N S9B-XH-A *2
Starting current	4.0A	Environment	Ambient temperature	*4 0 to +40°C
Motor starts running from RUN signal	≤ 15msec		Relative humidity	≤ 90%RH (no condensation)
Error signal discharge	PNP Open collector output (should be set to 25mA to less max output current)		Atmosphere	No corrosive gas
LED	Power (green) Error (red) Frequency (red/orange)		Vibration	≤ 0.5G
Protections	Integral 6.3A fuse (+ side) Diode against miss-wiring		Installation	Indoor
Thermister	95°C on PCB or 105°C in motor		Pollution level	2 *6
		Mechanical Brake	Timing of brake effected after stop signal	200msec
			Brake current	0.2A from start to 100msec and 0.125A thereafter

\*1 No holding effect. In case holding effect is required, use MDR with built-in brake option (BR) together with CB-016[BS7][BP7].

\*2 In case of CB-016[BS7][BP7], connector P/N is S10B-XH-A

\*3 ElectroMagnetic brake, which is disengaged from the motor when powered, and is engaged to the motor to stop inertia when power is off.

\*4 CB-016 driver card having LT option is used in the ambient temperature range between -30 and 10 °C. (no condensation)

\*5 In case of using UL recognized product.

\*6 Conforming to IEC60640-1 and UL840

\*7 Please select and use an appropriate cable according to the voltage used, the current, and the environment. There is a fear of a leak or a fire when an inappropriate cable is used.

## 12 Applicable standards (-UL)

### UL and CSA

UL508C and CSA C22.2-No.274 (Recognized component)

- Category Code No. (CCN) : NMMS2, NMMS8

- File No. : E333970

### Contacts:



**Headquarters: Itoh Denki Co.,Ltd.**

Phone: +81 (0)790 47 1225 Fax: +81 (0)790 47 1325 www.itohdenki.co.jp

**Europe, Middle East, Africa: Itoh Denki Europe SAS**

Phone: +33 (0)4 50 03 09 99 Fax: +33 (0)4 50 03 07 60 www.itoh-denki.com

**North & South America: Itoh Denki USA, Inc**

Phone: +1 570 820 8811 Fax: +1 570 820 8838 www.itohdenki.com

**Asia/Oceania: Itoh Denki Asia Limited**

Phone: +852 2427 2576 Fax: +852 2427 2203

**China: Itoh Denki Shanghai Company Limited**

Phone: +86 21 6341 0181 Fax: +86 21 6341 0180 www.itohdenki.com.cn

Specifications are subject to change without prior notice.

3-00K-1710