

# ULTIMATION

AN MCE COMPANY

## PRORUNNER MK1 - VERTICAL CONVEYOR



Also available in stainless steel



Up to -22 F



Key Components for material handling:

- Vertical Sorting
- Palletising Modules
- Sorting & Buffering
- Pallet Stackers
- Safety Fencing

## Advantages of the PRORUNNER® MK1

- Minimum footprint
- Suitable for vertical sorting (several heights)
- Right-angle arrangement also possible
- Boxes, crates and sacks up to 220 Lb.
- No lubrication or chain tensoning required
- Solid steel construction
- Robust and low maintenance
- Low noise level



Key Components for material handling:

- Vertical Conveyors
- Palletising Modules
- Sorters & Buffering
- Pallet Stackers
- Safety Fencing

Specifications Prorunner MK1		Basic model	Optional up to
Min. In/Outfeed	inch.	23.50	13.75
Max. In/Outfeed	inch.	103	447
Capacity	p/hour.	420	Checked per RFQ
Product (max LxW) *	inch.	24 x 24	36 x 24
Weight	lb.	66	220

\* Length side always parallel to lift column (=SSL side in/outfeed, LSL front in/outfeed).



37 ft

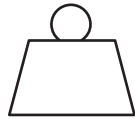
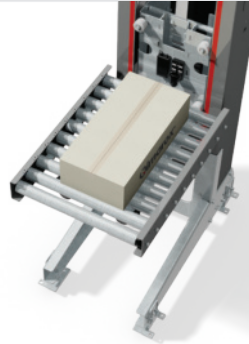

220 Lb

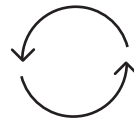
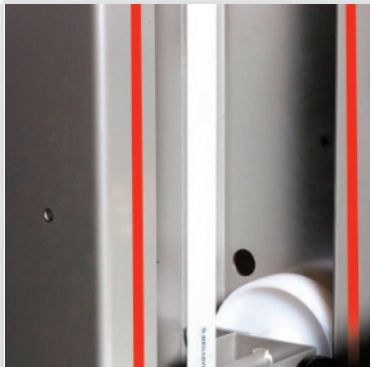
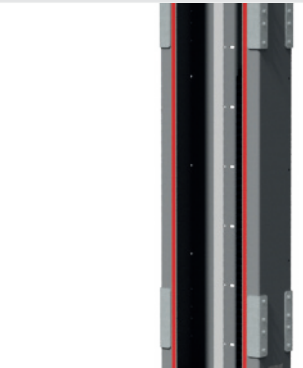

420 / h

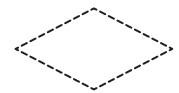
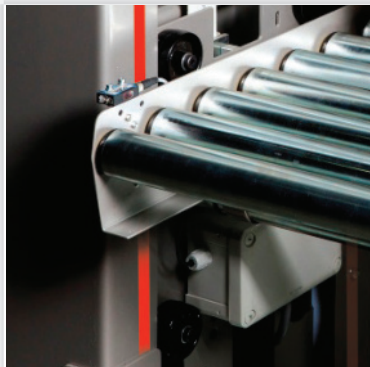

7,5 sq ft

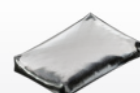

Key Components for material handling:

- Vertical Conveyors
- Palletising Modules
- Sorters & Buffering
- Pallet Stackers
- Safety Fencing

Customer: \_\_\_\_\_

E-mail: \_\_\_\_\_

Product: \_\_\_\_\_

Product sizes: ..... x ..... x ..... inch.

Capacity: min. .... p/min. max. .... p/min.

Product weight: min. .... Lb. max. .... LB.

Product orientation infeed: Short Side Leading Long Side Leading

Product orientation outfeed: Short Side Leading Long Side Leading

Product infeed: ..... inch.

Product outfeed: ..... inch.

Conveyor: Driven Gravity

Sensors: Yes No

Safety fencing: Yes No

Safety fencing door: Yes No

Operational: ..... / ..... | ..... / .....  
Hour / Day Days / Week

Lay-out: Send to info@ultimation.net

Environment conditions: \_\_\_\_\_

Remarks: \_\_\_\_\_

\_\_\_\_\_

\_\_\_\_\_

\_\_\_\_\_

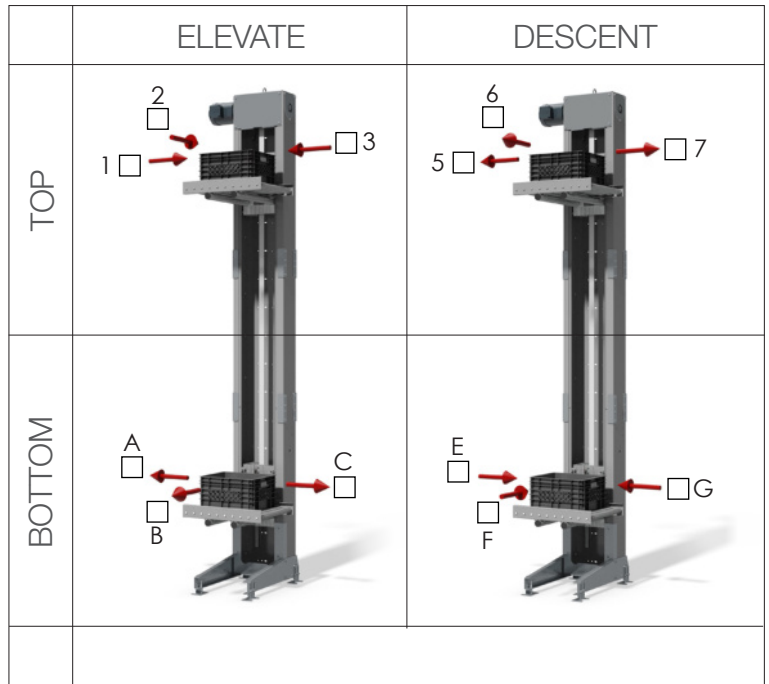

Suitable for

- Carton Trays • Bins • Tires • Books • Cardboard boxes • Shrink wrapped products • Soft parcels • Magazines
- Newspaper bundles • Frozen foods • Trays • Packaged bottles • Boxes • Bags • Totes

Disclaimer: This document is for informational en promotional purposes only.  
All orders are subject to the Qimarox terms and conditions and Qimarox's written confirmation. Copyright © 2022 Qimarox